

SECTION VIEW

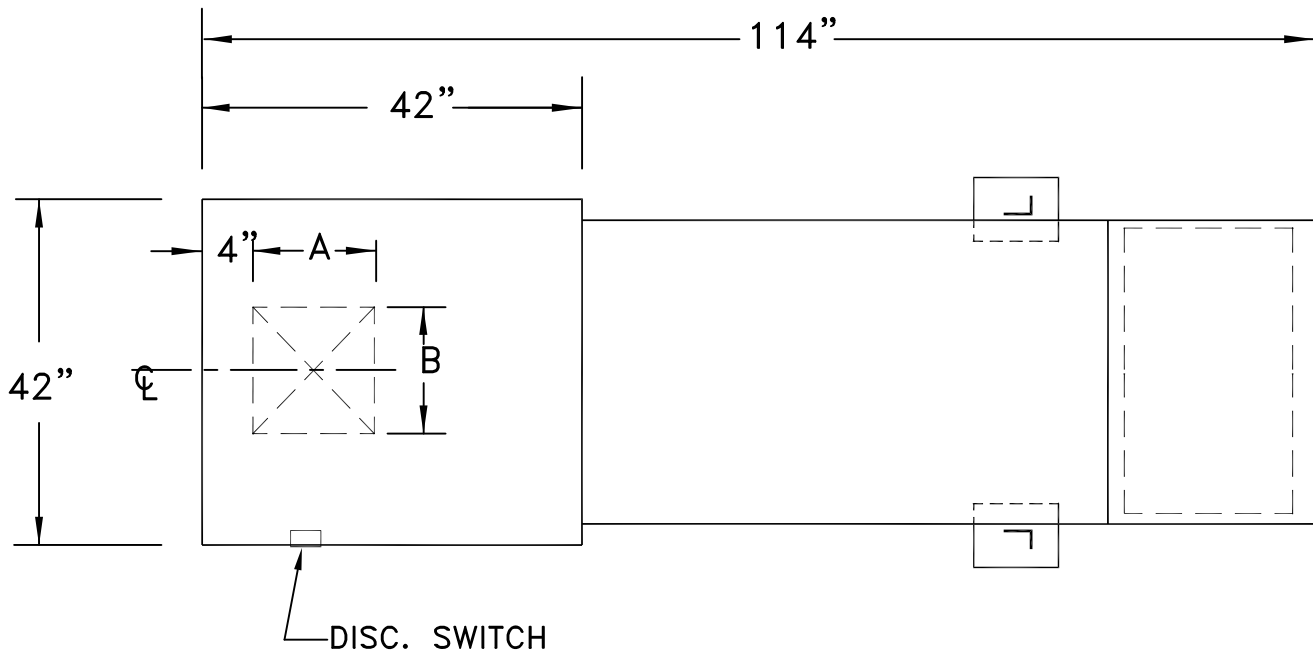

PLAN VIEW

SAS18-T