

SECTION VIEW

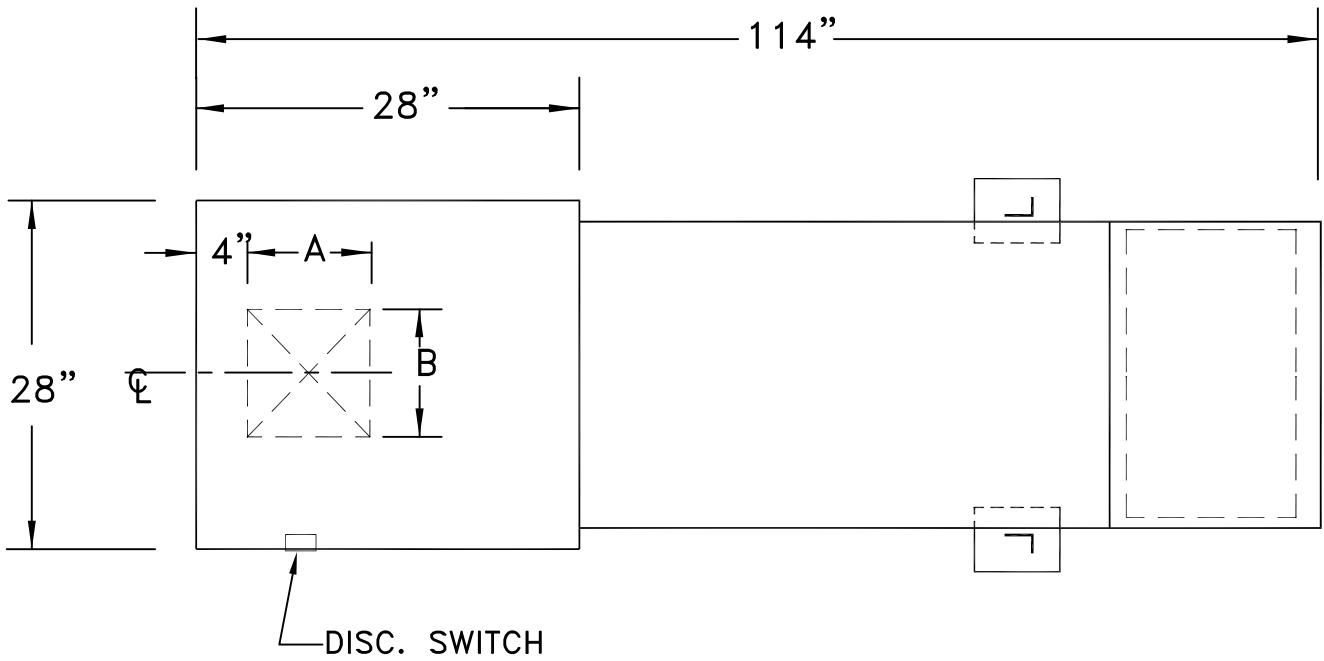

PLAN VIEW

SAS12-T